

Automotive Connector System up to 20 GHz | 28 Gbps

HFM® Products

High-Speed FAKRA-Mini

AUTOMOTIVE





Rosenberger Automotive – A Synonym for Quality and Innovation

On the following pages we present the high-quality Rosenberger HFM® connectors developed in our Automotive Business Area to fulfill the tough requirements of the automotive industry.



Rosenberger Automotive	4
HFM® Number Codes	6
HFM® Product Overview	8
HFM® Technical Data	14
HFM® Interface	15
HFM® Cable Connectors	16
HFM® Cable Connectors – Waterproof	22
HFM® PCB Connectors	24
HFM® PCB Connectors – Waterproof	27
HFM® Cable Assemblies	28
HFM® Calibration Kit	30
HFM® Accessories and Tools	32
HFM® Codings	34
Competencies & Technology	42
Quality & Environment	46
Rosenberger Global Network	48
Index	50

The Rosenberger online catalog contains the current Rosenberger HFM® product range with specific details, including data sheets, assembly instructions, and panel piercings.

www.rosenberger.com/ok/hfm

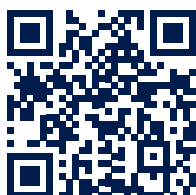

Rosenberger Automotive

At Rosenberger, we firmly believe in developing technology for the future. We are currently working on products and solutions that will shape our lives in the future.

We want to get faster and smarter in what we do and how we do it. Advanced driver assistance systems, connected car technology, electric mobility, infotainment systems – Rosenberger is extremely committed to designing innovative connector systems for future automotive electronics.

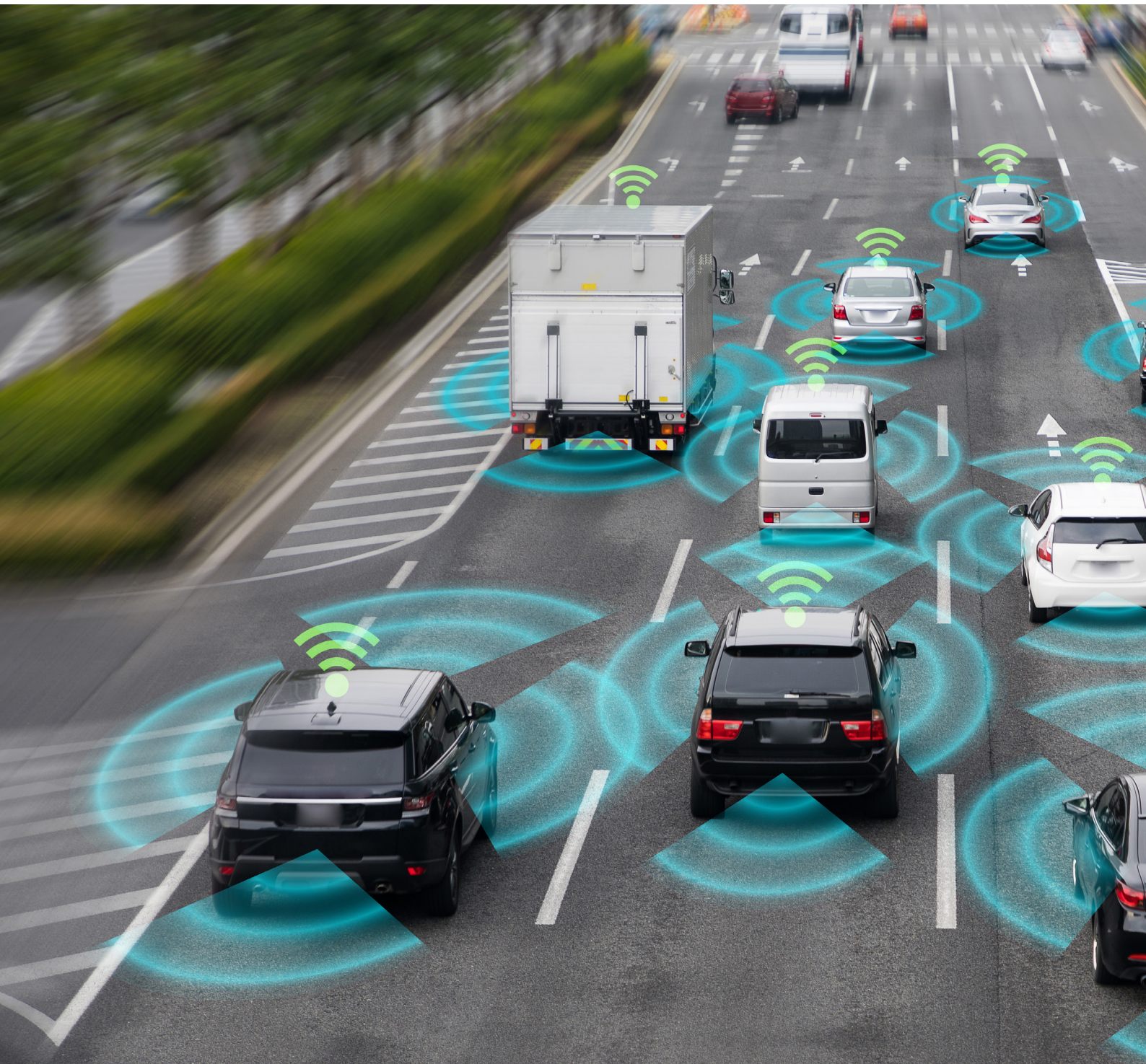



In 2000, Rosenberger started working in the automotive sector, designing and producing customized and standard products for these specific markets.

Rosenberger Automotive is a specialist development partner when it comes to integrating connector designs and customer-specific solutions with the highest quality and best performance – while continuing to meet customer price targets.

The contact systems have been specially designed to fulfill the tough requirements of the automotive industry. From the beginning, Rosenberger has developed a close and open relationship with its customers.

The priority in the most automotive applications, such as autonomous driving and driver assistance systems, is to ensure safety. It is necessary to determine exact positions, continuously calculate routes, and detect and classify objects. High data volumes from several cameras, various sensors, and navigation sources must be combined and transported for this purpose – in real time.

Application Areas

- Autonomous driving
- Driver assistance systems
- Navigation
- Infotainment
- Rear-entertainment
- Internet & mobile communication
- "WiGig" (Wireless Gigabit)

HFM® Cable Groups

Cable Group	Impedance	Cable Type
02	50 Ω	e.g. Dacar® 140 / Dacar® 462
03	50 Ω	e.g. 1.5 DS-QEHB / 1.5 DS QFB
AX	50 Ω	e.g. G&G CoSpeed5044
M4	50 Ω	e.g. G&G CoSpeed5031 / Dacar® 302

HFM® Plating Code

Outer Contact

Code	Plating	Symbol	Layer thickness	Magnetic properties
Z	Special plating			

Center Contact

Code	Plating	Symbol	Layer thickness	Magnetic properties
5	AuroDur®	Au	0.15 µm	non magnetic

The used platings of outer and center contacts of Rosenberger HFM® connectors can be identified by each part number.

Example:

AMK12A-102Z5-y

Plating outer contact: Tin (Z)

Plating center contact: Gold/AuroDur® (5)

AuroDur® – The Rosenberger Standard Plating for Gold Surfaces

AuroDur® plating is the standard gold surface for all Rosenberger connector series.

AuroDur® has been developed by the engineering and metallurgical team at Rosenberger, well-experienced in developing electroplating standards and customized surfaces.

The AuroDur® surface consists of a thin gold layer on a non-magnetic, chemically deposited layer of nickel:
min. 2 µm Ni, 0.15 µm Au

AuroDur® gold plating fully satisfies the high mechanical and electrical demands of radio frequency connectors. In contrast to conventional platings, essential characteristics are improved.

Properties:

- High abrasion and corrosion resistance
- Excellent intermodulation
- Low contact resistance
- Very good solderability
- Optimal distribution of layer thickness
- RoHS conform

HFM[®] Product Overview

HFM[®] – High-Speed FAKRA-Mini

Rosenberger HFM[®] is the best performing system of “Mini-Coax” connectors for the automotive industry. For frequencies up to 20 GHz, the intelligent modular system ensures fast transmission of high data rates up to 28 Gbps. Its innovative design addresses the growing requirement for cost savings as well as reduced weight and size.

Delivering space savings of up to 80 % compared to conventional FAKRA connectors, the Rosenberger HFM[®] connector system allows various modules to be accommodated in the smallest possible footprint.

Best cost is based on fully stamped and formed manufacturing processes and automated connector mounting and cable assembly. With HFM[®] the customer can count on an interface that accommodates future vehicle networks, applications and protocols.

The priority of autonomous driving and driver assistance systems is to ensure safety. It is required to determine exact positions, to continuously calculate routes and to detect and classify objects. High data volumes from several cameras, diverse sensors and navigation sources must be combined and transported for this purpose – in real time.

Rosenberger HFM[®] is compliant to all common automotive standards.

Reduced weight and size – space savings of up to 80 % compared to conventional FAKRA connectors

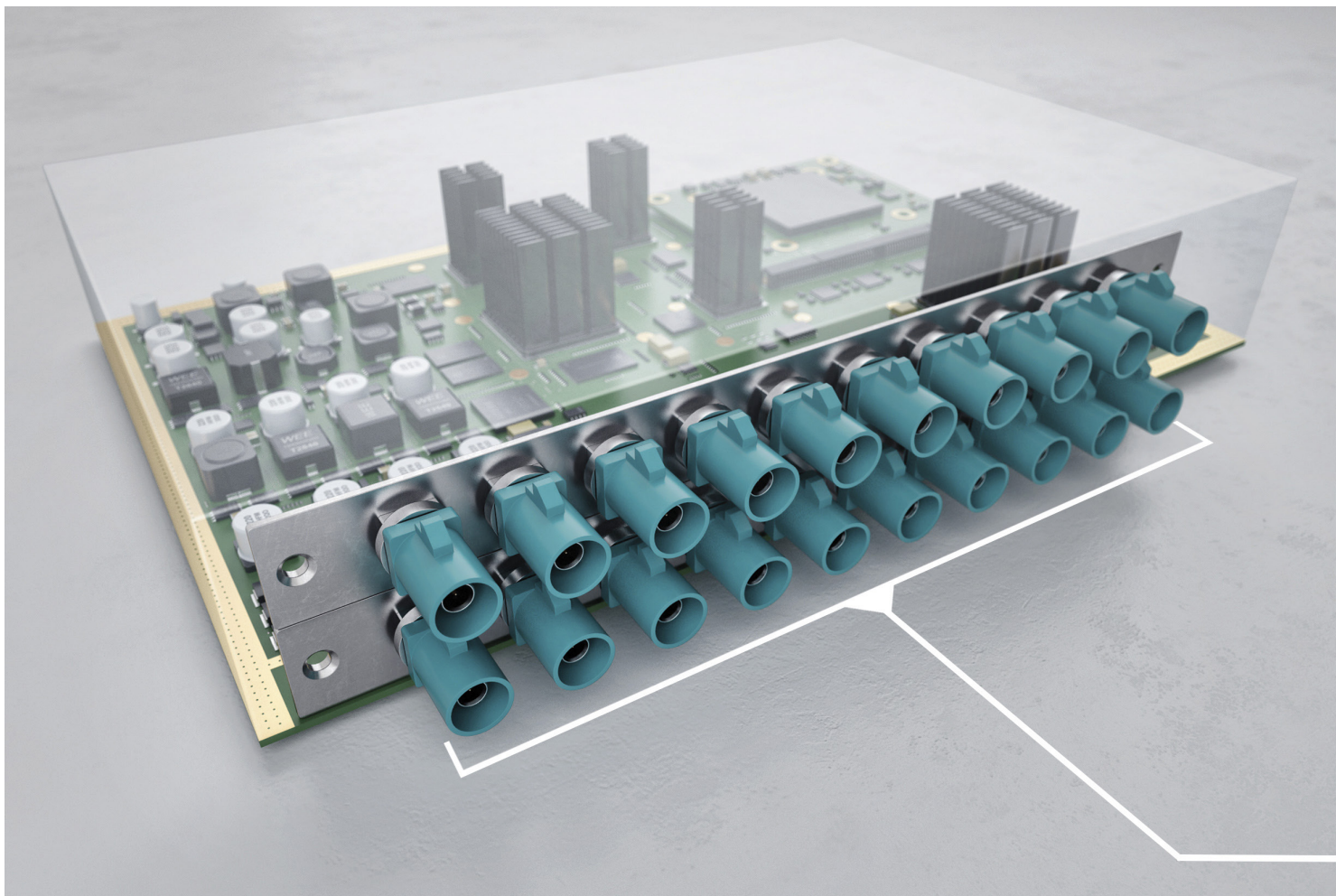

Space Comparison FAKRA versus HFM[®]

Protocols

- SERDES
 - APIX®
 - FPD-Link
 - GMSL™
 - MIPI A-PHYSM
 - PCIe®
 - USB
 - GVIF
 - HDBase-T™
 - ASA Motion Link

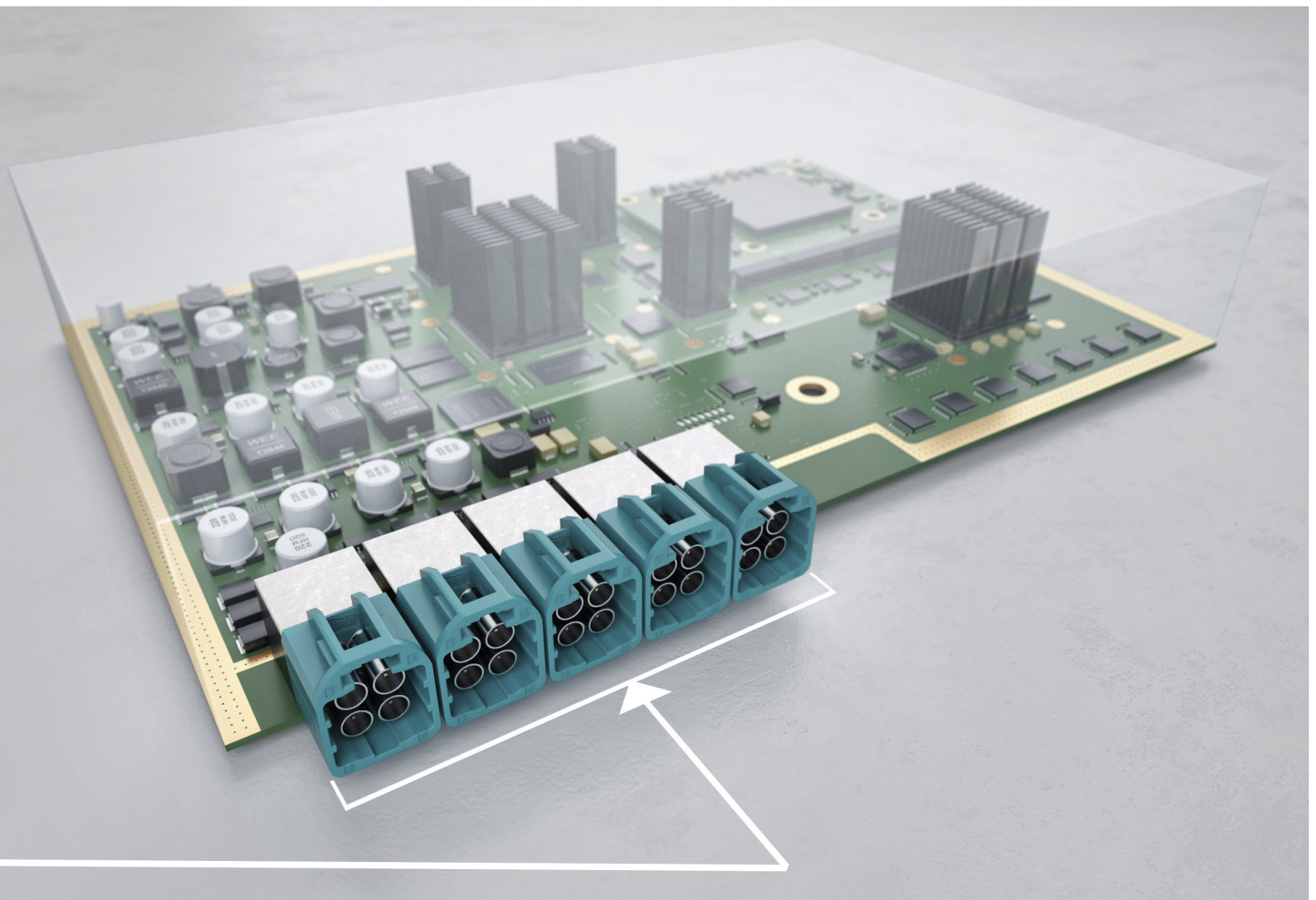
The logo for HFM, consisting of the letters 'HFM' in a large, bold, grey sans-serif font. Above the letters is a thick, grey, wavy horizontal line that tapers at both ends.

Product Portfolio

- Cable connectors (straight, right angle)
- PCB connectors (straight, right angle)
- Modular housings (single, double, quad)
- Cable assemblies
- Calibration kits
- Test-PCB boards and test accessories
- Waterproof versions
- CPA versions (Connector Position Assurance)

Features

- Impedance 50 Ω
- Frequency range DC up to 20 GHz
- High data rates up to 28 Gbps
- Return loss
 - ≥ 25 dB, DC to ≤ 3 GHz
 - ≥ 20 dB, > 3 GHz to ≤ 6 GHz
 - ≥ 15 dB, > 6 GHz to ≤ 12 GHz
 - ≥ 12 dB, > 12 GHz to ≤ 15 GHz
 - ≥ 10 dB, > 15 GHz to ≤ 20 GHz
- Mating cycles up to 25

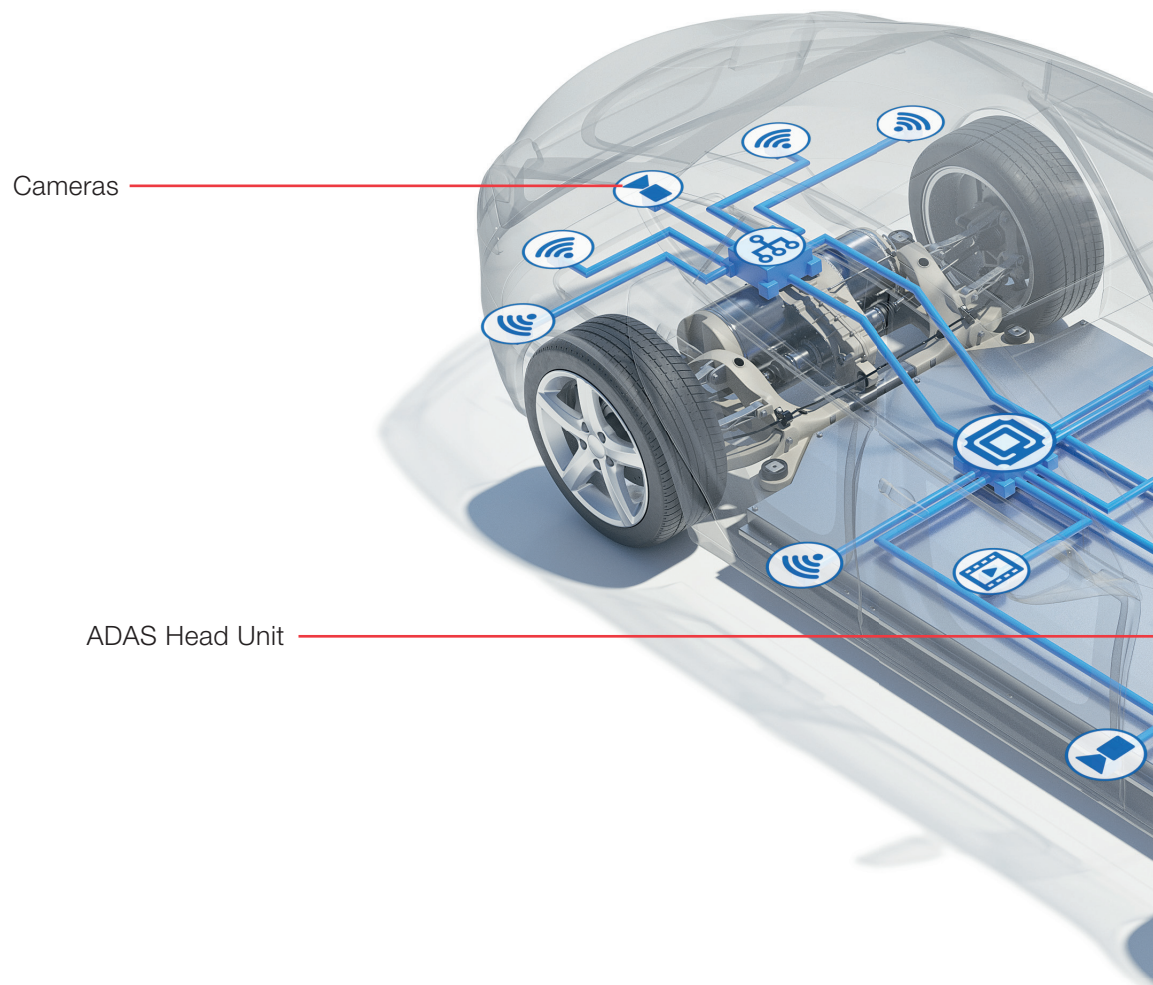

Wiring Harness Topologies

HFM® Connectors

The Rosenberger HFM® connection system meets all electrical and mechanical automotive requirements. It features mechanical keying, latching, color code options, further locking features and a minimum size combined with pleasing ergonomics.

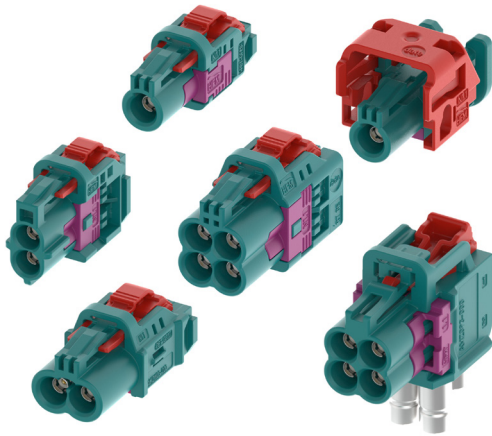
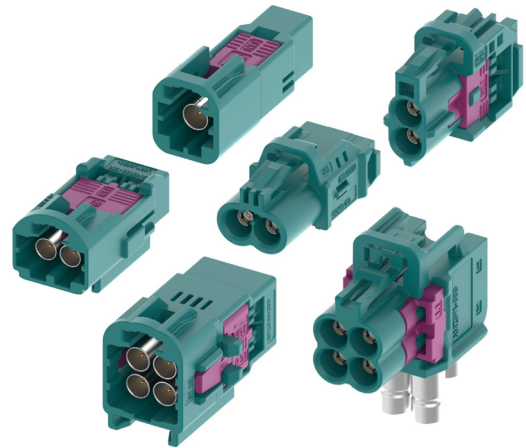

HFM® with CPA

Optional Connector Position Assurance prevents unintentional disengagement.

HFM® Waterproof Connectors

Mated waterproof Rosenberger HFM® connectors are suitable for outdoor use in the most demanding environments. The connectors are classified and tested according to ISO 20653 IPX9K. Limited mating cycles up to 5.

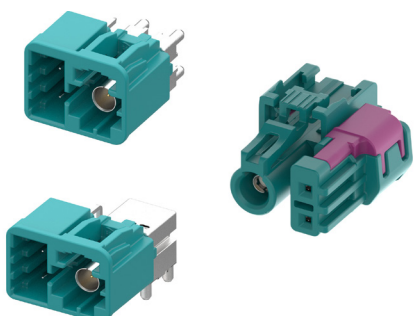
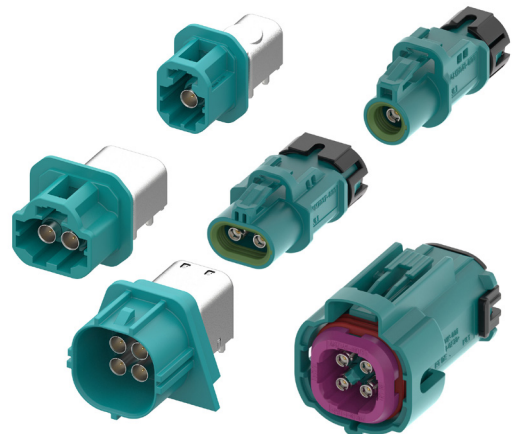

HFM®+2 Connectors

Rosenberger HFM®+2 power pin connectors – further variants with additional pins (MQS contacts) for power supply purposes.

Housing Designs

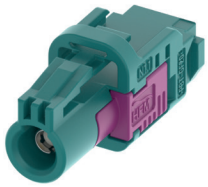

Single



Double

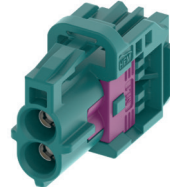

Double Vertical

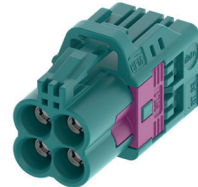

Quad

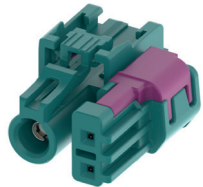

Single + MQS



Single Waterproof



Double Waterproof



Quad Waterproof

Connector Position Assurance – CPA prevents Unintentional Disengagement

High-speed data connectors are increasingly required in safety applications such as autonomous driving and driver assistance systems. In response, Rosenberger has developed an optional CPA (Connector Position Assurance) solution which improves connection reliability.

The CPA cannot be activated if the connector has not been completely mated. When aligned correctly the CPA can be closed. Additional products are available on request.

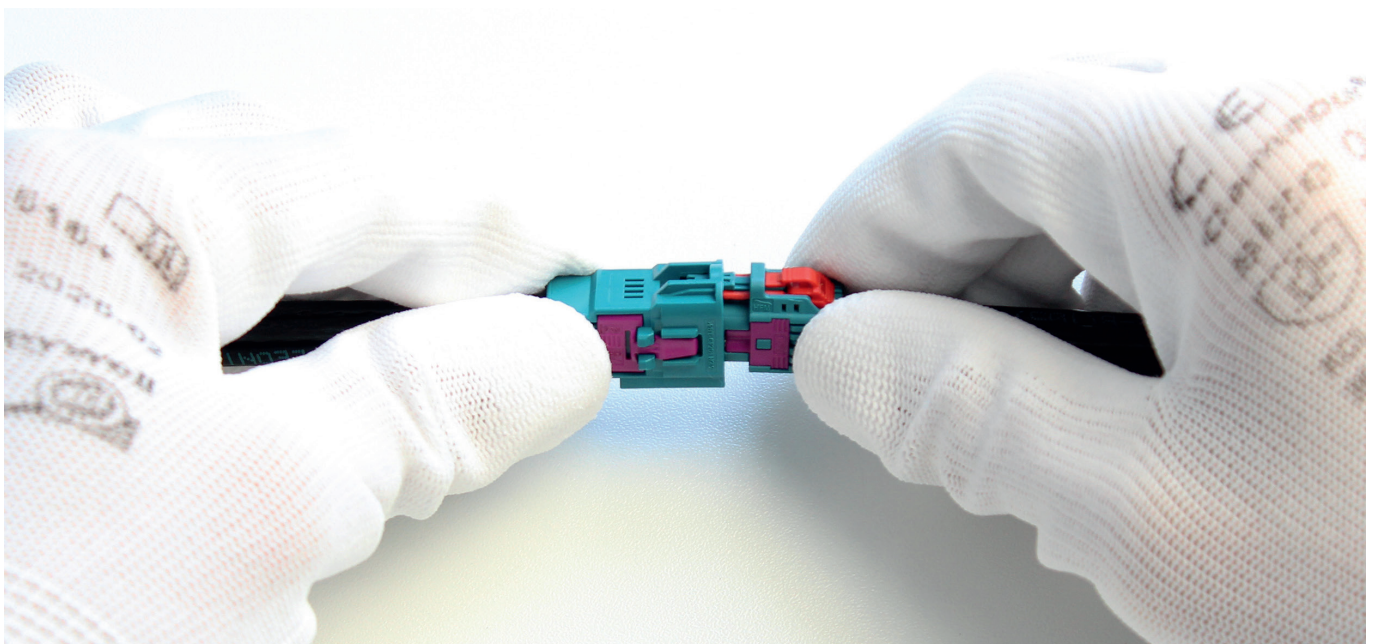

HFM[®] Technical Data (Code AM)

Applicable Standards

Interface according to	Rosenberger HFM [®] RN_108-01 Rosenberger HFM [®] RN_108-02 Rosenberger HFM [®] RN_108-03 Rosenberger HFM [®] RN_108-04
------------------------	----------------------------------------------------------------------------------------------------------------------------------------------------------------------

Electrical Data

Impedance	50 Ω
Frequency range (depends on cable)	DC to 20 GHz
Return loss	≥ 25 dB, DC to ≤ 3 GHz ≥ 20 dB, > 3 GHz to ≤ 6 GHz ≥ 15 dB, > 6 GHz to ≤ 12 GHz ≥ 12 dB, > 12 GHz to ≤ 15 GHz ≥ 10 dB, > 15 GHz to ≤ 20 GHz
Insertion loss	≤ 0.1 x √f(GHz) dB
Insulation resistance	≥ 1 x 10 ³ MΩ
Center contact resistance	≤ 15 mΩ
Outer contact resistance	≤ 5 mΩ
Test voltage	≤ 800 V rms
Working voltage	≤ 60 V DC
Contact current (depending on cable size)	≤ 1 A DC

Mechanical Data

Mating cycles (standard, non waterproof)	≥ 25
Mating cycles (waterproof)	≥ 5
Engagement force (single)	≤ 15 N
Engagement force (double)	≤ 30 N
Engagement force (quad)	≤ 45 N
Disengagement force (single)	≥ 2 N
Disengagement force (double)	≥ 2 N
Disengagement force (quad)	≥ 5 N
Retention force latch	≥ 110 N
Retention force primary lock	≥ 80 N
Retention force secondary lock	≥ 80 N
Coding efficiency	≥ 150 N

Environmental Data

Temperature range	-40 °C – +105 °C
Vibration/mechanical shock	ISO 20860-2 clause 9.1
Thermal shock	ISO 20860-2 clause 9.2
Temperature/humidity cycling	ISO 20860-2 clause 9.3
Dry heat	ISO 20860-2 clause 9.4
RoHS	compliant

Materials

Outer contact	Spring bronze, Stainless steel
Center contact	Spring bronze
Dielectric	PA12
Gasket	Silicone, Rubber
Crimping ferrule	Stainless steel
Plastic housings	PBT
Secondary lock	PBT

Platings

Outer contact	Tin, Special plating
Center contact	Au

Rosenberger-connectors fulfill in principle the indicated data of the Technical Data. Individual values of connectors may deviate depending upon application, design, type of cable, assembly method and execution. Specific data sheets for particular products can be provided on request from your Rosenberger sales partner.

HFM® Interface

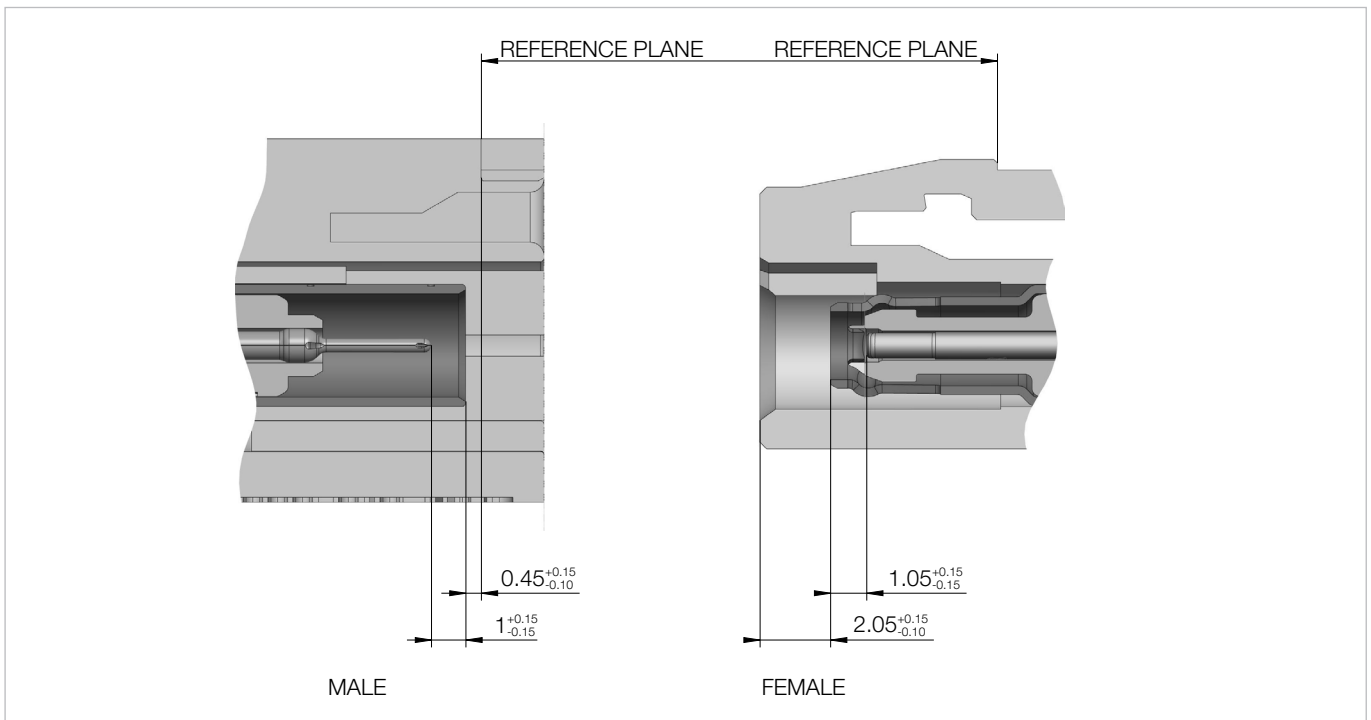

HFM[®] Connectors

Cable Connectors

Straight Jack



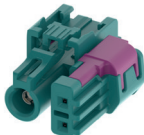

Rosenberger No.	Description	Cable Group	Product
AMK16A-102Z5-y AMK16A-1M4Z5-y AMK16A-103Z5-y AMK16A-1AXZ5-y	Cable jack single	02, 03 AX, M4	
AMK16B-102Z5-y AMK16B-1M4Z5-y AMK16B-103Z5-y AMK16B-1AXZ5-y	Cable jack double	02, 03 AX, M4	
AMK16C-102Z5-y AMK16C-1M4Z5-y AMK16C-103Z5-y AMK16C-1AXZ5-y	Cable jack double vertical	02, 03 AX, M4	
AMK12D-102Z5-y AMK12D-1M4Z5-y AMK12D-103Z5-y AMK12D-1AXZ5-y	Cable jack quad	02, 03 AX, M4	
AMK1CD-102Z5-y AMK1CD-1M4Z5-y AMK1CD-103Z5-y AMK1CD-1AXZ5-y	Cable jack quad with clip slot	02, 03 AX, M4	

Straight Jack, Single +2

Rosenberger No.	Description	Cable Group	Product
99K1A2-102Z5-y 99K1A2-1M4Z5-y 99K1A2-103Z5-y 99K1A2-1AXZ5-y	Cable jack single +2 MQS	02, 03 AX, M4	

Cable Connectors

Straight Plug

Rosenberger No.	Description	Cable Group	Product
AMS11A-102Z5-y AMS11A-1M4Z5-y AMS11A-103Z5-y AMS11A-1AXZ5-y	Cable plug single	02, 03 AX, M4	
AMS12A-102Z5-y AMS12A-1M4Z5-y AMS12A-103Z5-y AMS12A-1AXZ5-y	Cable plug single with clip slot	02, 03 AX, M4	
AMS11B-102Z5-y AMS11B-1M4Z5-y AMS11B-103Z5-y AMS11B-1AXZ5-y	Cable plug double with clip slot	02, 03 AX, M4	
AMS11D-102Z5-y AMS11D-1M4Z5-y AMS11D-103Z5-y AMS11D-1AXZ5-y	Cable plug quad with clip slot	02, 03 AX, M4	

y: Please fill-in required coding, availability of the specific coding on request

Cable Connectors

Straight Jack with CPA

Rosenberger No.	Description	Cable Group	Product
AMK1AA-1AXZ5-y	Cable jack single high-performance	AX	
AMK17A-102Z5-y AMK17A-1M4Z5-y AMK17A-103Z5-y AMK17A-1AXZ5-y	Cable jack single	02, 03 AX, M4	
AMK17B-102Z5-y AMK17B-1M4Z5-y AMK17B-103Z5-y AMK17B-1AXZ5-y	Cable jack double	02, 03 AX, M4	
AMK17C-102Z5-y AMK17C-1M4Z5-y AMK17C-103Z5-y AMK17C-1AXZ5-y	Cable jack double vertical	02, 03 AX, M4	
AMK11D-102Z5-y AMK11D-1M4Z5-y AMK11D-103Z5-y AMK11D-1AXZ5-y	Cable jack quad	02, 03 AX, M4	
AMK1CM-102Z5-y AMK1CM-1M4Z5-y AMK1CM-103Z5-y AMK1CM-1AXZ5-y	Cable jack quad with clip slot	02, 03 AX, M4	

y: Please fill-in required coding, availability of the specific coding on request

Cable Connectors

Straight Jack with CPA, Single +2

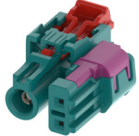
Rosenberger No.	Description	Cable Group	Product
99K1AB-102Z5-y 99K1AB-1M4Z5-y 99K1AB-103Z5-y 99K1AB-1AXZ5-y	Cable jack single +2 MQS	02, 03 AX, M4	

y: Please fill-in required coding, availability of the specific coding on request

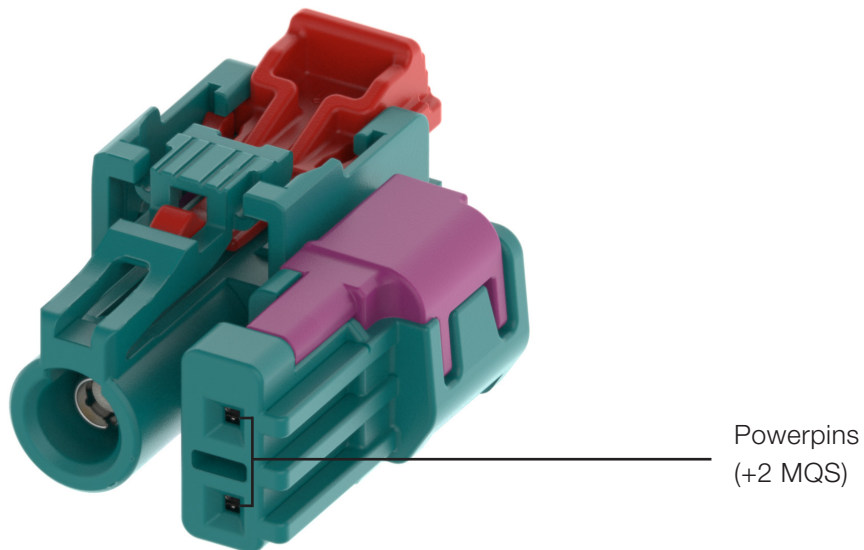

Cable Connectors

Right Angle Jack

Rosenberger No.	Description	Cable Group	Product
AMK21A-102Z5-y AMK21A-1M4Z5-y AMK21A-103Z5-y AMK21A-1AXZ5-y	Cable jack single	02, 03 AX, M4	
AMK21B-102Z5-y AMK21B-1M4Z5-y AMK21B-103Z5-y AMK21B-1AXZ5-y	Cable jack double	02, 03 AX, M4	
AMK21D-102Z5-y AMK21D-1M4Z5-y AMK21D-103Z5-y AMK21D-1AXZ5-y	Cable jack quad	02, 03 AX, M4	

y: Please fill-in required coding, availability of the specific coding on request

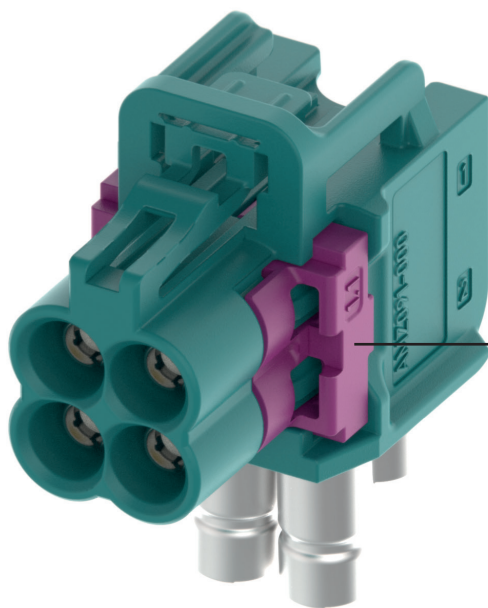

TPA
(Terminal Position Assurance)

Cable Connectors

Right Angle Jack with CPA

Rosenberger No.	Description	Cable Group	Product
AMK23A-102Z5-y AMK23A-1M4Z5-y AMK23A-103Z5-y AMK23A-1AXZ5-y	Cable jack single	02, 03 AX, M4	
AMK23B-102Z5-y AMK23B-1M4Z5-y AMK23B-103Z5-y AMK23B-1AXZ5-y	Cable jack double	02, 03 AX, M4	
AMK23D-102Z5-y AMK23D-1M4Z5-y AMK23D-103Z5-y AMK23D-1AXZ5-y	Cable jack quad	02, 03 AX, M4	

y: Please fill-in required coding, availability of the specific coding on request

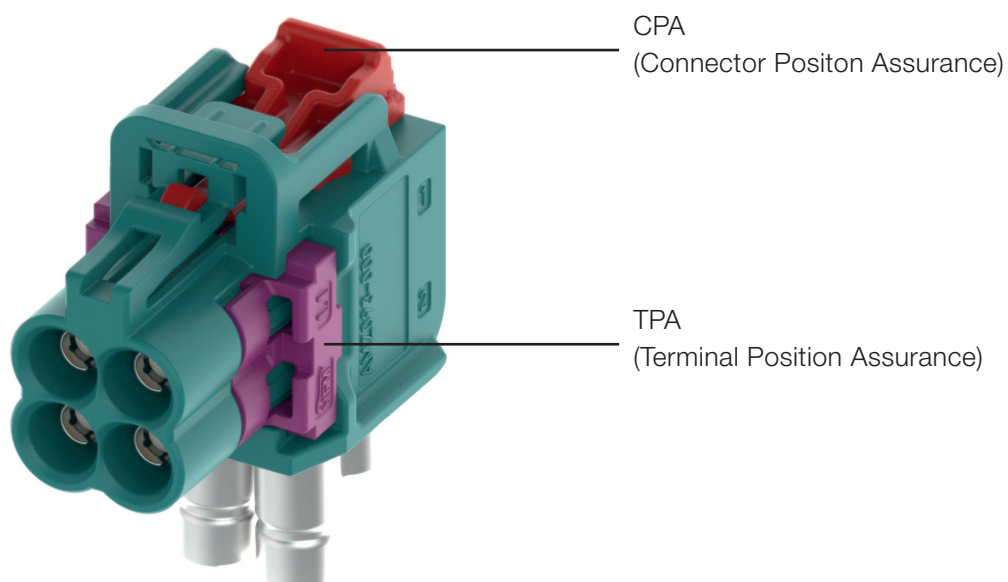

HFM® Connectors – Waterproof

Cable Connectors Waterproof

Straight Jack

Rosenberger No.	Description	Cable Group	Product
AMK141-102Z5-y AMK141-1M4Z5-y AMK141-103Z5-y AMK141-1AXZ5-y	Cable jack single waterproof	02, 03 AX, M4	
AMK142-102Z5-y AMK142-1M4Z5-y AMK142-103Z5-y AMK142-1AXZ5-y	Cable jack double waterproof	02, 03 AX, M4	
AMK148-102Z5-y AMK148-1M4Z5-y AMK148-103Z5-y AMK148-1AXZ5-y	Cable jack quad waterproof	02, 03 AX, M4	



Straight Plug

Rosenberger No.	Description	Cable Group	Product
AMS141-102Z5-y AMS141-1M4Z5-y AMS141-103Z5-y AMS141-1AXZ5-y	Cable plug single waterproof with clip slot	02, 03 AX, M4	
AMS142-102Z5-y AMS142-1M4Z5-y AMS142-103Z5-y AMS142-1AXZ5-y	Cable plug double waterproof with clip slot	02, 03 AX, M4	
AMS14D-102Z5-y AMS14D-1M4Z5-y AMS14D-103Z5-y AMS14D-1AXZ5-y	Cable plug quad waterproof with clip slot	02, 03 AX, M4	

y: Please fill-in required coding, availability of the specific coding on request

Cable Connectors Waterproof

Straight Jack with CPA

Rosenberger No.	Description	Cable Group	Product
AMK14G-102Z5-y AMK14G-1M4Z5-y AMK14G-103Z5-y AMK14G-1AXZ5-y	Cable jack single waterproof	02, 03 AX, M4	
AMK14H-102Z5-y AMK14H-1M4Z5-y AMK14H-103Z5-y AMK14H-1AXZ5-y	Cable jack double waterproof	02, 03 AX, M4	
AMK14K-102Z5-y AMK14K-1M4Z5-y AMK14K-103Z5-y AMK14K-1AXZ5-y	Cable jack quad waterproof	02, 03 AX, M4	

y: Please fill-in required coding, availability of the specific coding on request

HFM[®] Connectors

PCB Connectors – Pin-in-Paste

Right Angle Plug

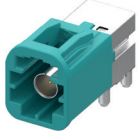
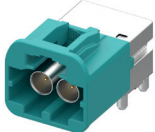
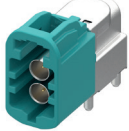
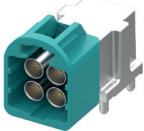
Rosenberger No.	Description	Panel Piercing / PCB Layout	Product
AMS29A-40MZ5-y	PCB plug pin-in-paste single	MB 603	
AMS29B-40MZ5-y	PCB plug pin-in-paste double horizontal	MB 616	
AMS29C-40MZ5-y	PCB plug pin-in-paste double vertical	MB 793	
AMS29D-40MZ5-y	PCB plug pin-in-paste quad	MB 604	

y: Please fill-in required coding, availability of the specific coding on request

PCB Connectors – Pin-in-Paste

Right Angle Plug

Rosenberger No.	Description	Panel Piercing / PCB Layout	Product
AMS2RA-40MZ5-y	PCB plug pin-in-paste single cable right	MB 603	
AMS2LA-40MZ5-y	PCB plug pin-in-paste single cable left	MB 603	
AMS2UA-40MZ5-y	PCB plug pin-in-paste single cable up	MB 603	
AMS2UB-40MZ5-y	PCB plug pin-in-paste double horizontal cable up	MB 616	
AMS2UC-40MZ5-y	PCB plug pin-in-paste double vertical cable up	MB 793	
AMS2UD-40MZ5-y	PCB plug pin-in-paste quad cable up	MB 604	

y: Please fill-in required coding, availability of the specific coding on request

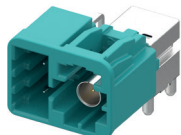

Right Angle Plug, Single +2

Rosenberger No.	Description	Panel Piercing / PCB Layout	Product
99S2AP-40MZ5-y	PCB plug pin-in-paste single +2 MQS cable down	MB 873	

y: Please fill-in required coding, availability of the specific coding on request

PCB Connectors – Pin-in-Paste

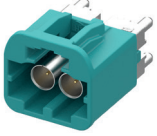
Straight Plug

Rosenberger No.	Description	Panel Piercing / PCB Layout	Product
AMS19A-40MZ5-y	PCB plug pin-in-paste single	MB 929	
AMS19B-40MZ5-y	PCB plug pin-in-paste double	MB 710	
AMS19D-40MZ5-y	PCB plug pin-in-paste quad	MB 639	

y: Please fill-in required coding, availability of the specific coding on request

Straight Plug, Single +2

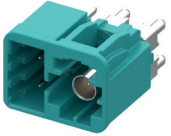
Rosenberger No.	Description	Panel Piercing / PCB Layout	Product
99S1AP-40MZ5-y	PCB plug pin-in-paste single +2 MQS	MB 852	

y: Please fill-in required coding, availability of the specific coding on request

PCB Connectors EMC

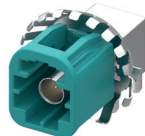
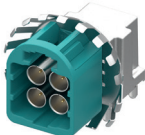

Right Angle Plug with EMC Shielding

Rosenberger No.	Description	Panel Piercing / PCB Layout	Product
AMS29P-40MZ5-y	PCB plug pin-in-paste single with EMC shielding	MB 603	
AMS29S-40MZ5-y	PCB plug pin-in-paste quad with EMC shielding	MB 604	

y: Please fill-in required coding, availability of the specific coding on request

PCB Connectors Waterproof – Pin-in-Paste

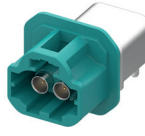
Right Angle Plug

Rosenberger No.	Description	Panel Piercing / PCB Layout	Product
AMS24A-40MZ5-y	PCB plug pin-in-paste single waterproof	MB 827	
AMS24B-40MZ5-y	PCB plug pin-in-paste double waterproof	MB 828	
AMS24D-40MZ5-y	PCB plug pin-in-paste quad waterproof	MB 885	

y: Please fill-in required coding, availability of the specific coding on request

HFM[®] Cable Assemblies

Rosenberger offers a comprehensive range of standard cable assemblies as well as customized solutions for high speed data transmissions.



Cable variants with different center contact sections are available.

Custom specific versions on request, please feel free to contact us.

Rosenberger Number Code – Cable Assemblies Rosenberger HFM[®]

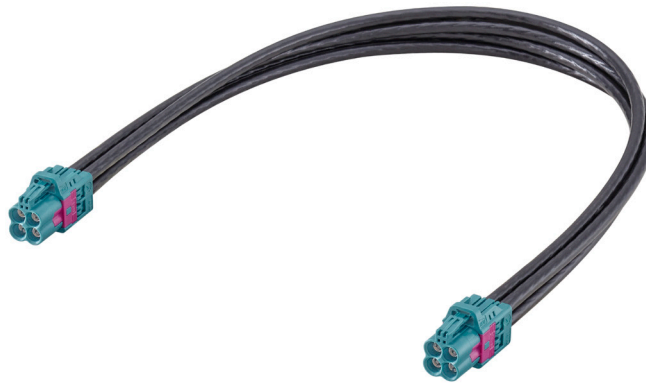
L	xx-	101-	xxxx-	-y-y
				Coding Side A and B
				A Black
				B White
				C Blue
				D Bordeauxviolet
				E Green
				F Brown
				G Grey
				H Light Pink
				J Beige
				K Curry
				N Pastel Green
				Z Waterblue
				y Placeholder for required coding
				Length in mm
				Successive number,
				Include assembled connectors,
				for details please see data sheet
				Cable group
				02
				03
				M4
				AX
				Cable assembly

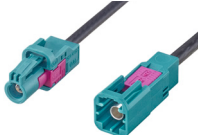

Rosenberger No.	Remarks	Cable Group	Side A	Side B	Product
L02-008-xxxx-y-y	xxxx: length in mm y-y: coding side A/B	02, 03, AX, M4 on request	HFM® jack, straight single	HFM® jack, straight single	
L02-009-xxxx-y-y	xxxx: length in mm y-y: coding side A/B	02, 03, AX, M4 on request	HFM® jack, straight single	HFM® plug, straight single	
L02-025-xxxx-y-yyyy	xxxx: length in mm y-yyyy: coding side A/B	02, 03, AX, M4 on request	HFM® jack, straight quad	4x HFM® jack, straight single	

xxxx: Please fill-in required cable length in mm. Custom specific versions on request, please feel free to contact us.

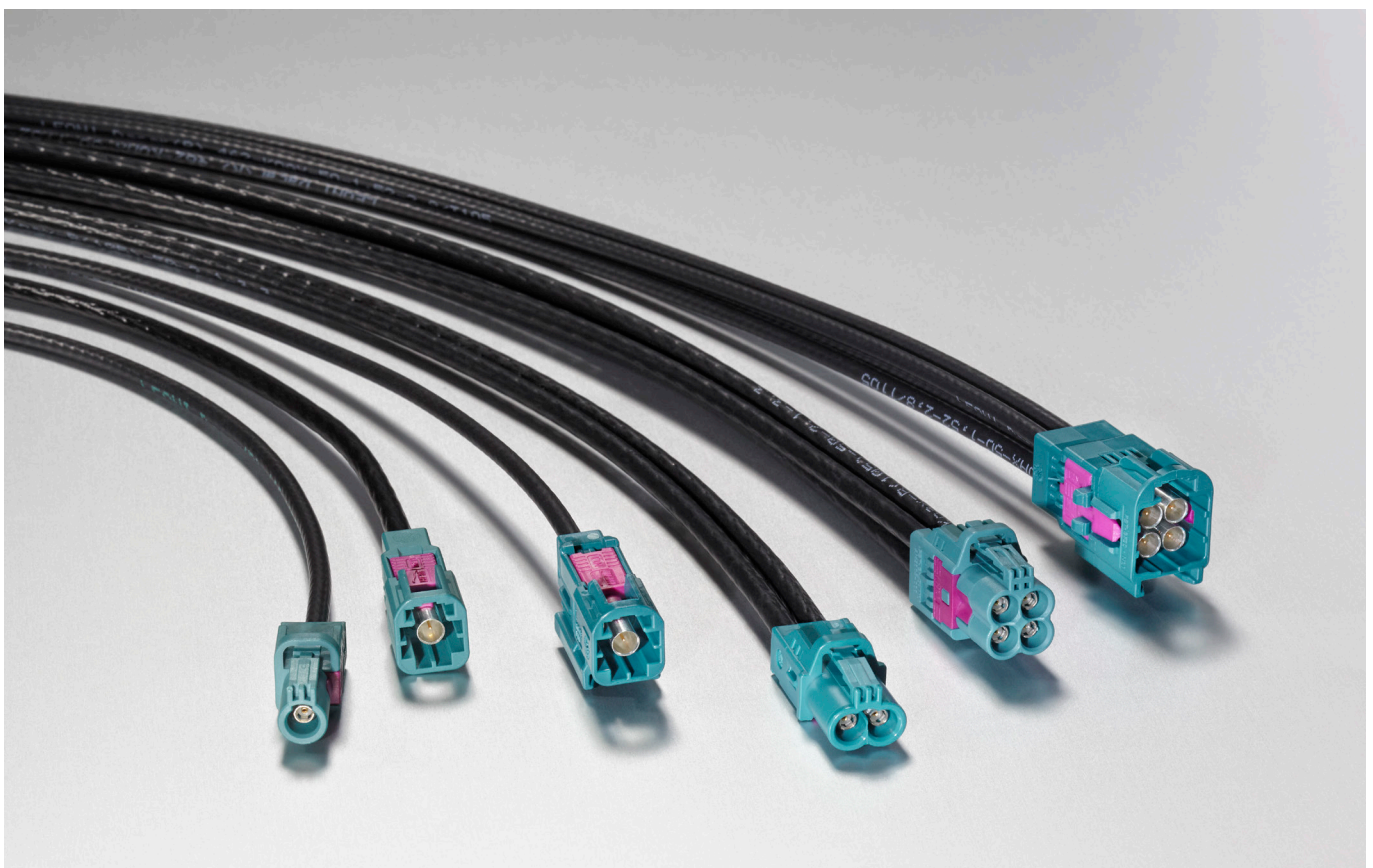

HFM® Calibration Kit

Calibration Kit, Full Version

Rosenberger No.	Description	Product
AMCK010-150	Rosenberger calibration kits are delivered in stable wooden boxes including factory calibration certificate. Please use the following part numbers for ordering single components.	

Contents of Calibration Kit, Full Version

Rosenberger No.	Description	Packing Unit
02S12L-0AMS3	Open circuit RPC-2.92 male	1
02K12L-0AMS3	Open circuit RPC-2.92 female	1
02S12S-0AMS3	Short circuit RPC-2.92 male	1
02K12S-0AMS3	Short circuit RPC-2.92 female	1
02S150-CAMS3	Calibration load RPC-2.92 male	1
02K150-CAMS3	Calibration load RPC-2.92 female	1
02K1AM-S00S3	Calibration adaptor RPC-2.92 female / HFM® male	1
02K1AM-K00S3	Calibration adaptor RPC-2.92 female / HFM® female	1
02S1AM-S00S3	Calibration adaptor RPC-2.92 male / HFM® male	1
02S1AM-K00S3	Calibration adaptor RPC-2.92 male / HFM® female	1
03W008-000	Combi wrench	1
03W021-000	Torque wrench	1
AMZ001-000Z	Plastic housing HFM® female	10
AMZ010-000Z	Plastic housing HFM® male	10



Calibration Kit, Adaptor Version

Rosenberger No.	Description
AMCK070-150	Rosenberger calibration kits are delivered in stable wooden boxes including factory calibration certificate. Please use the following part numbers for ordering single components.

Contents of Calibration Kit, Adaptor Version

Rosenberger No.	Description	Packing Unit
02K1AM-S00S3	Calibration adaptor RPC-2.92 female / HFM® male	1
02K1AM-K00S3	Calibration adaptor RPC-2.92 female / HFM® female	1
02S1AM-S00S3	Calibration adaptor RPC-2.92 male / HFM® male	1
02S1AM-K00S3	Calibration adaptor RPC-2.92 male / HFM® female	1
AMZ001-000Z	Plastic housing HFM® female	10
AMZ010-000Z	Plastic housing HFM® male	10

Calibration Kit, Universal Version

Rosenberger No.	Description
AMCK080-150	Rosenberger calibration kits are delivered in stable wooden boxes including factory calibration certificate. Please use the following part numbers for ordering single components.

Contents of Calibration Kit, Universal Version





Rosenberger No.	Description	Packing Unit
02K1AM-S01S3	Calibration adaptor RPC-2.92 female / HFM® male, housing for universal use	1
02K1AM-K01S3	Calibration adaptor RPC-2.92 female / HFM® female, housing for universal use	1
02S1AM-S01S3	Calibration adaptor RPC-2.92 male / HFM® male, housing for universal use	1
02S1AM-K01S3	Calibration adaptor RPC-2.92 male / HFM® female, housing for universal use	1

HFM® Accessories and Tools

Precision Adaptors with HFM® Housing

Rosenberger No.	Description	Connectors	Packing Unit	Product
02K1AM-K00S3	Adaptor with HFM® housing single	RPC-2.92 female HFM® female	1	
02K1AM-S00S3	Adaptor with HFM® housing single	RPC-2.92 female HFM® male	1	
02S1AM-K00S3	Adaptor with HFM® housing single	RPC-2.92 male HFM® female	1	
02S1AM-S00S3	Adaptor with HFM® housing single	RPC-2.92 male HFM® male	1	

Precision Adaptors without HFM® Housing for Universal Use

Rosenberger No.	Description	Connectors	Packing Unit	Product
02K1AM-K01S3	Adaptor without HFM® housing single	RPC-2.92 female HFM® female	1	
02K1AM-S01S3	Adaptor without HFM® housing single	RPC-2.92 female HFM® male	1	
02S1AM-K01S3	Adaptor without HFM® housing single	RPC-2.92 male HFM® female	1	
02S1AM-S01S3	Adaptor without HFM® housing single	RPC-2.92 male HFM® male	1	

Repair Tool Kit HFM®

Rosenberger No.	Description	Cable Group	Packing Unit	Product
AMW001-SET	Complete tool kit incl. 4 tools: – cutting and stripping tool – crimping tool for support sleeve – crimping tool for female center and outer contact – crimping tool for male center and outer contact	M4	1	
AMW007-SET		O2	1	
AMW021-SET		AX	1	

Further tools and tool kits are available on request

Testboard HFM®

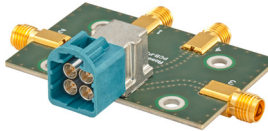
Rosenberger No.	Description	Coding	Packing Unit	Product
PCB-P3001-SB	Impedance 50 Ω	1xHFM® male AMS22D-40MZ5-y 4x RPC-2.92 female 02K249-40ML5	1	
PCB-T2503-SB-01	Impedance 50 Ω	1x HFM® male AMS29A-40MZ5-y 4x RPC-2.92 female 02K721-40MS3	1	
PCB-T2504-SB-01	Impedance 50 Ω	1x HFM® male AMS29B-40MZ5-y 4x RPC-2.92 female 02K721-40MS3	1	
PCB-T2505-SB-01	Impedance 50 Ω	1xHFM® male AMS29C.40MZ5-y 4x RPC-2.92 female 02K721-40MS3	1	

HFM[®] Codings

Coding Rosenberger HFM[®] Single

Coding	Jack	Plug	Color / RAL-No. (similar)
A			Black / 9005 
B			White / 9010 
C			Blue / 5012 
D			Bordeauxviolet / 4004 
E			Green / 6017 
F			Brown / 8011 
G			Gray / 7036 
H			Light Pink / 3015 
J			Beige / 1001 
K			Curry / 1027 
N			Pastel Green / 6019 
Z (neutral coding)			Waterblue / 5021 

Availability of specific codings upon request. Color of the plastic housing defined in accordance to the listed RAL colors. Minor color differences due to manufacturing possible.

Coding Rosenberger HFM® Single, Waterproof

Coding	Jack	Plug	Color / RAL-No. (similar)
A			Black / 9005 
B			White / 9010 
C			Blue / 5012 
D			Bordeauxviolet / 4004 
E			Green / 6017 
F			Brown / 8011 
G			Gray / 7036 
H			Light Pink / 3015 
J			Beige / 1001 
K			Curry / 1027 
N			Pastel Green / 6019 
Z (neutral coding)			Waterblue / 5021 





















Availability of specific codings upon request. Color of the plastic housing defined in accordance to the listed RAL colors. Minor color differences due to manufacturing possible.

Coding Rosenberger HFM® Double, Horizontal

Coding	Jack	Plug	Color / RAL-No. (similar)
A			Black / 9005 
B			White / 9010 
C			Blue / 5012 
D			Bordeauxviolet / 4004 
E			Green / 6017 
F			Brown / 8011 
G			Gray / 7036 
H			Light Pink / 3015 
J			Beige / 1001 
K			Curry / 1027 
N			Pastel Green / 6019 
Z (neutral coding)			Waterblue / 5021 

Availability of specific codings upon request. Color of the plastic housing defined in accordance to the listed RAL colors. Minor color differences due to manufacturing possible.

Coding Rosenberger HFM® Double, Vertical

Coding	Jack	Plug	Color / RAL-No. (similar)
A			Black / 9005 
B			White / 9010 
C			Blue / 5012 
D			Bordeauxviolet / 4004 
E			Green / 6017 
F			Brown / 8011 
Z (neutral coding)			Waterblue / 5021 













Availability of specific codings upon request. Color of the plastic housing defined in accordance to the listed RAL colors. Minor color differences due to manufacturing possible.

Coding Rosenberger HFM® Double, Horizontal, Waterproof

Coding	Jack	Plug	Color / RAL-No. (similar)
A			Black / 9005 
B			White / 9010 
C			Blue / 5012 
D			Bordeauxviolet / 4004 
E			Green / 6017 
F			Brown / 8011 
G			Gray / 7036 
H			Light Pink / 3015 
J			Beige / 1001 
K			Curry / 1027 
N			Pastel Green / 6019 
Z (neutral coding)			Waterblue / 5021 









Availability of specific codings upon request. Color of the plastic housing defined in accordance to the listed RAL colors. Minor color differences due to manufacturing possible.

Coding Rosenberger HFM® Quad

Coding	Jack	Plug	Color / RAL-No. (similar)
A			Black / 9005 
B			White / 9010 
C			Blue / 5012 
D			Bordeauxviolet / 4004 
E			Green / 6017 
F			Brown / 8011 
G			Gray / 7036 
Z (neutral coding)			Waterblue / 5021 

Availability of specific codings upon request. Color of the plastic housing defined in accordance to the listed RAL colors. Minor color differences due to manufacturing possible.

Coding Rosenberger HFM® Quad, Waterproof

Coding	Jack	Plug	Color / RAL-No. (similar)
A			Black / 9005 
B			White / 9010 
C			Blue / 5012 
D			Bordeauxviolet / 4004 
E			Green / 6017 
F			Brown / 8011 
Z (neutral coding)			Waterblue / 5021 

Availability of specific codings upon request. Color of the plastic housing defined in accordance to the listed RAL colors. Minor color differences due to manufacturing possible.

Competencies & Technology

Rosenberger's mission is to be a leader when it comes to innovation and technology within its business segments.

An ongoing focus on cost management and process optimization complements our commitment to the increasingly stringent market requirements for delivering products of the highest quality. Effective research & development, the very latest manufacturing technologies, the highest possible levels of efficiency in production processes, and continuous improvement of process automation make up Rosenberger's core competencies.

Using state-of-the-art production, Rosenberger can continue to develop and optimize key manufacturing technologies – turned parts production, stamped & formed technology, injection molding technology.

Manufacturing everything in house ensures a high degree of flexibility which combined with continuous quality controls ensures newly designed products can be produced in the required quantities. With acceptable tolerances now in the range of one hundredth of a millimeter, the production of electronic connectors requires the highest precision.





Automated Connector Mounting and Cable Assembling

At Rosenberger various machine types are used for enabling precise and extreme deformation of raw materials and fast throughput of large quantities. In addition to extensive stamping, forming and embossing operations, Rosenberger machines are used to join, laser-weld and, if required, laser-mark large quantities of pieces. This takes place directly in the processing area with minimum set-up and assembly times.

The necessary tool construction for the specially equipped stamping and forming assembly machines are designed and produced as far as possible in the company's own tool shop.

Rosenberger uses various raw materials including pure and partially tinned copper, copper-tin and stainless steel strips.

Stamping Technologies

The Rosenberger Group meets the increasing requirements with its high-quality stamping technology. Competence and experience guarantees reliable pluggability as well as highly resilient, stamped and formed (SF) connectors; especially under demanding conditions such as those found in the automotive industry. Rosenberger quality is assured by the adoption of fully automated processes with 100 % repeatability. Maximum efficiency is achieved by the involvement of the potential harness makers as early as the design phase of the respective SF connectors.

Benefits of Stamping & Forming

- Cost optimization
- Reduced use of materials
- Fast production of large quantities
- Guaranteed plug compatibility
- Process-safe manufacturing
- Precision

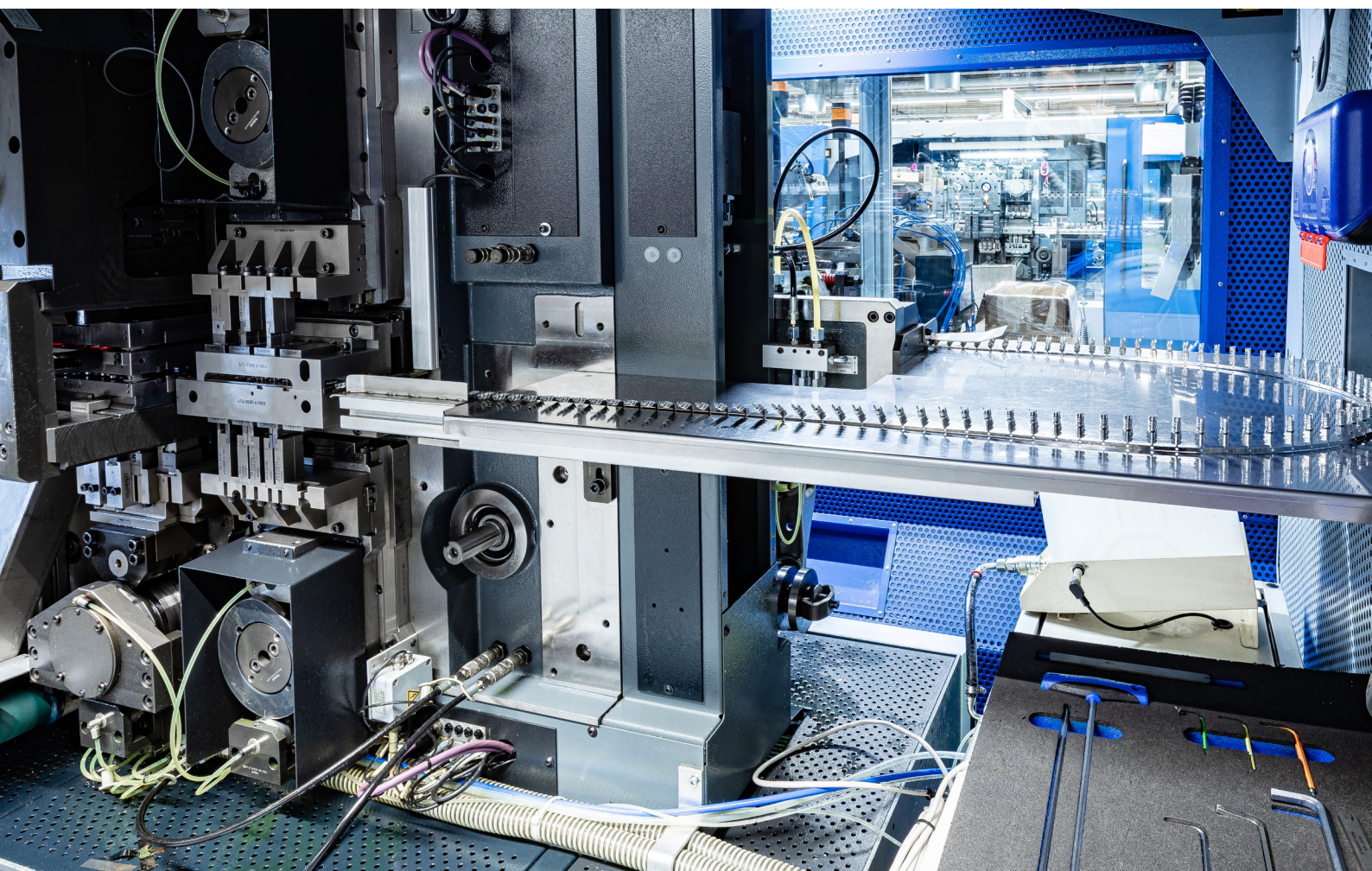

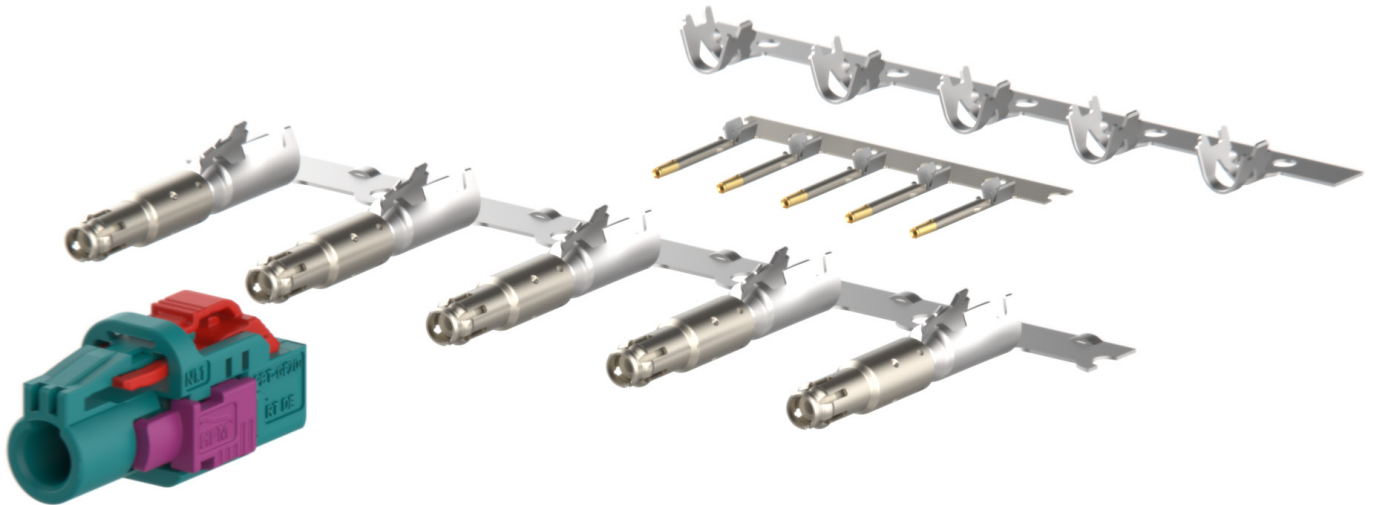

Belting & Packing – Tape & Reel

For high volume production, stamped and formed connector parts such as outer contacts/connector bodies, center/inner contacts or support sleeves can be delivered on reels only.

Information about high-volume production and assembly, special tools for cable assembly and ordering procedure of packing units is available on request: automotive@rosenberger.com



Stamping Technologies at Rosenberger

Quality & Environment

The quality of Rosenberger products, solutions and services is an essential part of our corporate strategy.

Ensuring the optimum quality of products and services and taking responsibility for our environment are fundamental elements of Rosenberger's corporate philosophy. Our quality philosophy does not only cover the optimization of parts and products, but also the continuous improvement of all company processes: from product development, planning, procurement, production, sales, logistics right through to environmental policy. To summarize, we want to offer maximum benefits for our customers all over the world.

We aim to act in an environmentally conscious manner, use materials economically, protect natural resources, recycle, and ensure energy efficiency.

In recognition of continuously improving processes and applying quality management systems, Rosenberger has won a number of prestigious quality and environmental excellence awards.

Complete Control with Innovative Technology

Industrial image processing guarantees fully automatic machine inspection. A combination of hardware and software ensures error-free execution of complex production. Digital sensors inside industrial cameras with special optics for image acquisition analyze and monitor all process steps. If products are in need of adjustment they are immediately scanned prior to checking for errors against the respective design data.

IMDS System

Rosenberger is registered with the IMDS system (Internationales MaterialDatenSystem der Automobilindustrie) since 2001. The products are fed systematically into the IMDS system.

www.mdsystem.com





Certificates

- IATF 16949
- DIN EN 9100
- ISO 9001
- ISO 14001
- ISO 50001
- DaKKs accreditation according to DIN EN ISO 17025

Rosenberger Global Network

Rosenberger is one of the world's leading manufacturers of impedance controlled and optical connectivity solutions. It provides connectivity solutions in high-frequency, high-voltage, and fiber-optic technology for mobile communication networks, data centers, test & measurement applications, automotive electronics, as well as high-voltage contact systems, medical electronics or aerospace engineering.

A global network of R&D, manufacturing and assembly locations provides innovation, optimized cost structure and excellent customer services world-wide more than 12,000 employees develop, produce and sell our products.

Contacts Automotive

Headquarters

Rosenberger

Rosenberger Hochfrequenztechnik GmbH & Co. KG
Hauptstraße 1 | 83413 Fridolfing
P.O. Box 1260 | 84526 Tittmoning
Germany
Phone +49 8684 18-0
info@rosenberger.com
www.rosenberger.com

Sales Automotive

Europe

Germany

Rosenberger Hochfrequenztechnik
GmbH & Co. KG
Hauptstraße 1
83413 Fridolfing
Germany
Phone + 49-8684-18-1694
automotive@rosenberger.com

France

Rosenberger Automotive France
43 Rue de Belfort
25200 Montbeliard
France
Phone + 33 9 87 71 67 67
Mobile + 33 7 87 50 51 59
automotive.france@rosenberger.com

Italy

Rosenberger Italia Srl
Via Torri Bianche 7 - Piano 7
20871 Vimercate (MI)
Italy
Phone + 39-039-96 30306
info-italia@rosenberger.com

Spain

Rosenberger Telecom, S.A.
C/Lozoya nº2, nave 18 -
P.I. Ventorro del Cano
28925 Alcorcón - Madrid
Spain
Phone + 34 91 352 8352
Fax + 34 91 352 9813
rosenberger@rosenberger.es

Sweden

Rosenberger Sverige AB
Fågelsångsvägen 7B
18642 Vallentuna
Sweden
Phone + 46 8 636 2600
info@rosenberger.se

United Kingdom

Rosenberger UK Ltd.
York House, Cottingley Business Park
Bradford, BD16 1PE
England
United Kingdom
Phone + 44-7980 730423
automotive.uk@rosenberger.com

North America

USA

Rosenberger Automotive USA
Fairlane Office Center
4 Parklane Boulevard, Suite 307
Dearborn, MI 48126
United States of America
Phone + 1-734-673 4131
Phone + 1-248-259 5750
automotive.usa@rosenberger.com





The Rosenberger headquarters, located in Fridolfing in the southeast part of Bavaria, Germany, is the global center for our activities.

South America

Brazil

Rosenberger Domex Telecom Ltda.
 Cabletech Avenue, 601
 Guamirim
 CEP 12295-230
 BR-Cacapava - São Paulo
 Brazil
 Phone + 55-12-3221 8500
 Fax + 55-12-3221 8543
vendas@rosenbergerdomex.com.br

Chile

Rosenberger Sudamérica Ltda.
 Aldunate 1961,
 Santiago 836-1195
 Chile
 Phone + 56-2-3 67 11 70
 Fax + 56-2-3 67 12 78
rosenberger@rosenberger.cl

Asia

China, Asia, Australia

Rosenberger
 Asia Pacific Electronic Co., Ltd.
 No. 3, Anxiang Road, Block B
 Tianzhu Airport Industrial Zone
 Beijing 101300
 PR China
 Phone + 86-10-80 48 19 95
 Fax + 86-10-80 48 24 38
info@rosenberger.com.cn

Japan

Rosenberger Automotive Japan, LLC.
 Asahi Building
 16-3 Nihonbashi Kabuto-Cho, Chuo-Ku
 103-0026 Tokyo
 Japan
 Phone + 813 5511 2525
automotive.japan@rosenberger.com

Korea

Rosenberger Automotive Korea
 #1104, ACE Gwanggyo Tower 3
 77, Changnyong-daero 256beon-gil,
 Yeongtong-gu, Suwon-si, Gyeonggi-do,
 16229
 Republic of Korea
 Phone + 82 70 7779 2236
 Mobile + 82 10 4729 6194
automotive.korea@rosenberger.com

India

Rosenberger Electronic Co. (India) Pvt
 Limited
 Plot No. 263, Sector 6
 IMT Manesar, Gurgaon
 Haryana-122050
 India
 Phone + 91-124-477 55 00
 Fax + 91-124-477 55 01
info@rosenberger.in

Rosenberger No.

02K12L-0AMS3	30	AMK14K-1AXZ5-y	23
02K12S-0AMS3	30	AMK14K-1M4Z5-y	23
02K150-CAMS3	30	AMK16A-102Z5-y	16
02K1AM-K00S3	30, 31, 32	AMK16A-103Z5-y	16
02K1AM-K01S3	31, 32	AMK16A-1AXZ5-y	16
02K1AM-S00S3	30, 31, 32	AMK16A-1M4Z5-y	16
02K1AM-S01S3	31, 32	AMK16B-102Z5-y	16
02S12L-0AMS3	30	AMK16B-103Z5-y	16
02S12S-0AMS3	30	AMK16B-1AXZ5-y	16
02S150-CAMS3	30	AMK16B-1M4Z5-y	16
02S1AM-K00S3	30, 31, 32	AMK16C-102Z5-y	16
02S1AM-K01S3	31, 32	AMK16C-103Z5-y	16
02S1AM-S00S3	30, 31, 32	AMK16C-1AXZ5-y	16
02S1AM-S01S3	31, 32	AMK16C-1M4Z5-y	16
03W00B-000	30	AMK17A-102Z5-y	18
03W021-000	30	AMK17A-103Z5-y	18
99K1A2-102Z5-y	16	AMK17A-1AXZ5-y	18
99K1A2-103Z5-y	16	AMK17A-1M4Z5-y	18
99K1A2-1AXZ5-y	16	AMK17B-102Z5-y	18
99K1A2-1M4Z5-y	16	AMK17B-103Z5-y	18
99K1AB-102Z5-y	19	AMK17B-1AXZ5-y	18
99K1AB-103Z5-y	19	AMK17B-1M4Z5-y	18
99K1AB-1AXZ5-y	19	AMK17C-102Z5-y	18
99K1AB-1M4Z5-y	19	AMK17C-103Z5-y	18
99S1AP-40MZ5-y	26	AMK17C-1AXZ5-y	18
99S2AP-40MZ5-y	25	AMK17C-1M4Z5-y	18
AMCK010-150	30	AMK1AA-1AXZ5-y	18
AMCK070-150	31	AMK1CD-102Z5-y	16
AMCK080-150	31	AMK1CD-103Z5-y	16
AMK11D-102Z5-y	18	AMK1CD-1AXZ5-y	16
AMK11D-103Z5-y	18	AMK1CD-1M4Z5-y	16
AMK11D-1AXZ5-y	18	AMK1CM-102Z5-y	18
AMK11D-1M4Z5-y	18	AMK1CM-103Z5-y	18
AMK12D-102Z5-y	16	AMK1CM-1AXZ5-y	18
AMK12D-103Z5-y	16	AMK1CM-1M4Z5-y	18
AMK12D-1AXZ5-y	16	AMK21A-102Z5-y	20
AMK12D-1M4Z5-y	16	AMK21A-103Z5-y	20
AMK141-102Z5-y	22	AMK21A-1AXZ5-y	20
AMK141-103Z5-y	22	AMK21A-1M4Z5-y	20
AMK141-1AXZ5-y	22	AMK21B-102Z5-y	20
AMK141-1M4Z5-y	22	AMK21B-103Z5-y	20
AMK142-102Z5-y	22	AMK21B-1AXZ5-y	20
AMK142-103Z5-y	22	AMK21B-1M4Z5-y	20
AMK142-1AXZ5-y	22	AMK21D-102Z5-y	20
AMK142-1M4Z5-y	22	AMK21D-103Z5-y	20
AMK148-102Z5-y	22	AMK21D-1AXZ5-y	20
AMK148-103Z5-y	22	AMK21D-1M4Z5-y	20
AMK148-1AXZ5-y	22	AMK23A-102Z5-y	21
AMK148-1M4Z5-y	22	AMK23A-103Z5-y	21
AMK14G-102Z5-y	23	AMK23A-1AXZ5-y	21
AMK14G-103Z5-y	23	AMK23A-1M4Z5-y	21
AMK14G-1AXZ5-y	23	AMK23B-102Z5-y	21
AMK14G-1M4Z5-y	23	AMK23B-103Z5-y	21
AMK14H-102Z5-y	23	AMK23B-1AXZ5-y	21
AMK14H-103Z5-y	23	AMK23B-1M4Z5-y	21
AMK14H-1AXZ5-y	23	AMK23D-102Z5-y	21
AMK14H-1M4Z5-y	23	AMK23D-103Z5-y	21
AMK14K-102Z5-y	23	AMK23D-1AXZ5-y	21
AMK14K-103Z5-y	23	AMK23D-1M4Z5-y	21

AMS11A-102Z5-y	17	AMS19D-40MZ5-y	26
AMS11A-103Z5-y	17	AMS24A-40MZ5-y	27
AMS11A-1AXZ5-y	17	AMS24B-40MZ5-y	27
AMS11A-1M4Z5-y	17	AMS24D-40MZ5-y	27
AMS11B-102Z5-y	17	AMS29A-40MZ5-y	24
AMS11B-103Z5-y	17	AMS29B-40MZ5-y	24
AMS11B-1AXZ5-y	17	AMS29C-40MZ5-y	24
AMS11B-1M4Z5-y	17	AMS29D-40MZ5-y	24
AMS11D-102Z5-y	17	AMS29P-40MZ5-y	27
AMS11D-103Z5-y	17	AMS29S-40MZ5-y	27
AMS11D-1AXZ5-y	17	AMS2LA-40MZ5-y	25
AMS11D-1M4Z5-y	17	AMS2RA-40MZ5-y	25
AMS12A-102Z5-y	17	AMS2UA-40MZ5-y	25
AMS12A-103Z5-y	17	AMS2UB-40MZ5-y	25
AMS12A-1AXZ5-y	17	AMS2UC-40MZ5-y	25
AMS12A-1M4Z5-y	17	AMS2UD-40MZ5-y	25
AMS141-102Z5-y	22	AMW001-SET	33
AMS141-103Z5-y	22	AMW007-SET	33
AMS141-1AXZ5-y	22	AMW021-SET	33
AMS141-1M4Z5-y	22	AMZ001-000Z	30, 31
AMS142-102Z5-y	22	AMZ010-000Z	30, 31
AMS142-103Z5-y	22	L02-008-xxxx-y-y	29
AMS142-1AXZ5-y	22	L02-009-xxxx-y-y	29
AMS142-1M4Z5-y	22	L02-025-xxxx-y-yyyy	29
AMS14D-102Z5-y	22	PCB-P3001-SB	33
AMS14D-103Z5-y	22	PCB-T2503-SB-01	33
AMS14D-1AXZ5-y	22	PCB-T2504-SB-01	33
AMS14D-1M4Z5-y	22	PCB-T2505-SB-01	33
AMS19A-40MZ5-y	26		
AMS19B-40MZ5-y	26		

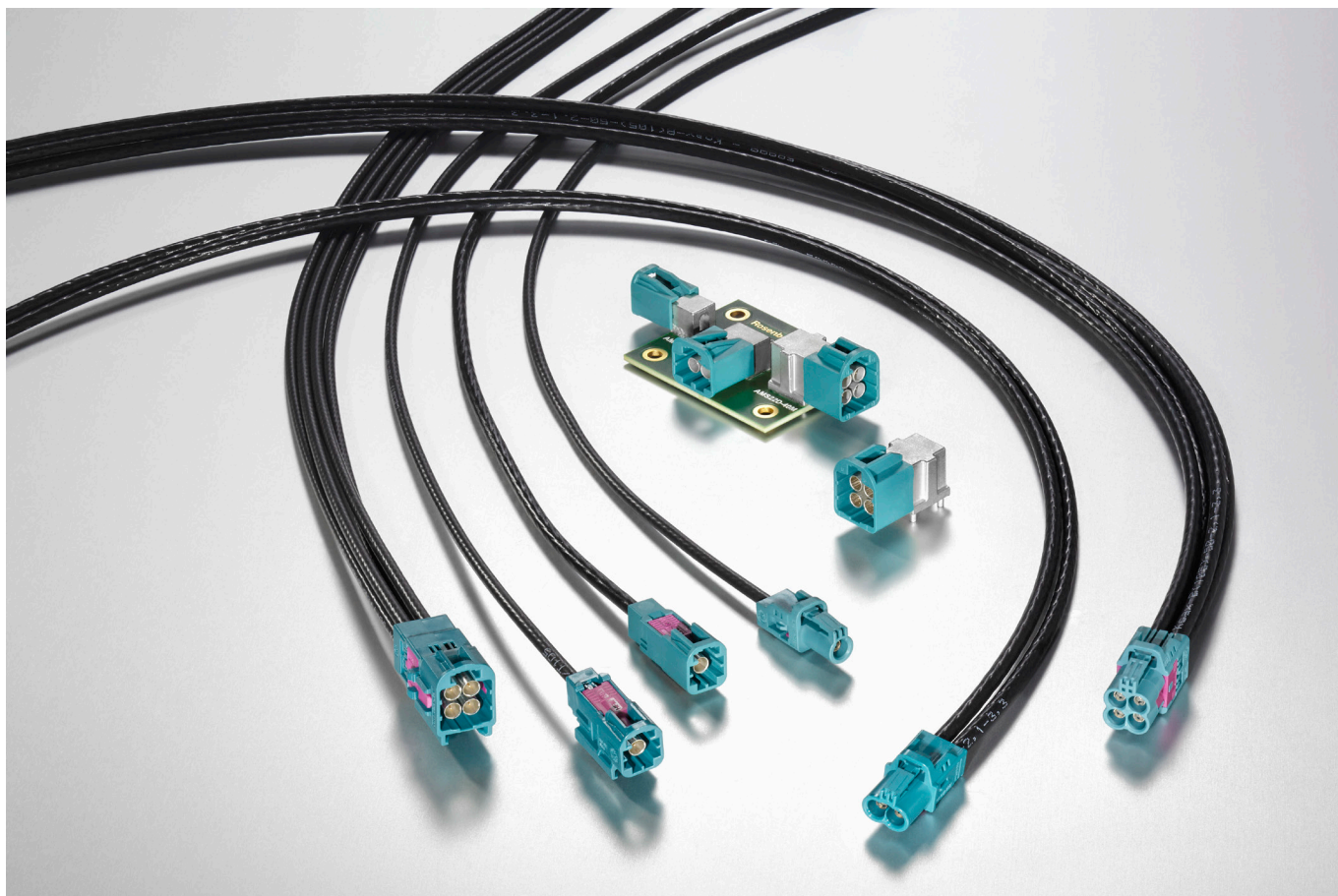



Website

For more information refer to our website:
www.rosenberger.com/hfm

Rosenberger

Rosenberger Hochfrequenztechnik GmbH & Co. KG

Hauptstraße 1 | 83413 Fridolfing

P.O. Box 1260 | 84526 Tittmoning

Germany

Phone +49 8684 18-0

info@rosenberger.com

www.rosenberger.com

Certified by IATF 16949 · DIN EN 9100 · ISO 9001 · ISO 14001 · ISO 50001

Order No.

pA 319549 · Info211HFMcatEN

2000/2022

Rosenberger® and HFM® are registered trademarks of Rosenberger Hochfrequenztechnik GmbH & Co. KG.
All rights reserved.

© Rosenberger 2022